

Conveyor Belt Misalignment Switch

HESEX

ATEX  II 2D Ex tD A21 IP 65 T 85 °C

Leaflet No. **Kiepe 510**



APPLICATION

Kiepe Belt Misalignment Switches are used in conveyor installations for monitoring the true running of conveyor belts. The switches, when mounted at the running edges of a conveyor belt, will be operated if the belt deviates from its designed running line by more than a permissible distance.

The Kiepe Belt Misalignment Switches HESEX are approved for use in areas with combustible dusts acc. to EN 50281-1-1, part 1-1: Electrical apparatus protected by enclosures.

The switches are marked with  II 2D Ex tD A21 IP 65 T 85 °C and can be used in zones 21 and 22, equipment group II, categories 2 and 3.

The Belt Misalignment Switch HESEX is used for conveyor installations subjected to especially severe operating conditions. The actuating roller of stainless steel is carried in stainless steel ball bearings for improved handling of lateral forces and jerks.

The large roller diameter of 48 mm permits the use of this device where fast belt speeds prevail. All external parts are either of stainless steel or have been specially plated.

The trip points are to be adjusted within 5 and 15° resp. 15 and 35° by means of movable actuating cams.

TECHNICAL DATA

In compliance with the following standards and regulations	EN 50281-1-1, Part 1-1, Ex II 2D EN 60947-5-1, VDE 0110 - degree of pollution 2 (interior), 4 (exterior)
Suitable for	controls and equipment acc. to EN 60204
Enclosure	Aluminium, EN-AC-AISI 12
Finish	2-component DD-tile enamel, yellow RAL 1004
Mounting	2 long holes for screws M8
Permissible ambient temperature (VDE 0660)	$-25\text{ °C} \leq T_{\text{amb}} \leq +75\text{ °C}$
Max. operating temperature of enclosure	85 °C
IP protection class	IP 65 acc. to EN 60529
Switching system	Snap-acting switch, 2 changeover contacts
Type of operation	Actuating roller, 48 mm diameter, stainless steel
Switching points	Adjustable within 5° to 15° resp. 15° to 35° Standard setting is $2 \times 10^\circ$
Excursion	max. 75°
Rated insulation voltage U_i	380V AC, 250V DC
Conventional thermal current I_{th}	6 A
Breaking capacity AC 15:	$U_e = 240\text{ V AC}, I_e = 1,5\text{ A}$ 24V DC, T = 2-3 ms, up to 3 A
Contact service life	$0,5 \cdot 10^6$ switching cycles
Mechanical operating life	$> 10^5$ switching cycles
Cable entry	Tapped hole for 2 x M25 x 1,5
1 x cable gland M25 x 1,5; sealing area $\varnothing 11,5\text{ mm}$ to $\varnothing 15,5\text{ mm}$ 1 x Plug M25 x 1,5	
Connections	max. 1,5 mm ²
Equipotential bonding connection	Connectable conductors: 4 mm ² finely-stranded, 6 mm ² monofilar
Earth	Inside the housing M4
Ordering code	92.058 645.011

ACCESSORIES

Use only cable glands and plugs recommended by the manufacturer and supplied with the switch. These cable glands and plugs are designed acc. to ATEX EU design sample test certification.

The use of other cable glands and plugs may lead to a void device type approval.

Cable gland	113.52.01.20.01
Plug	113.52.87.20.01

DIMENSIONS

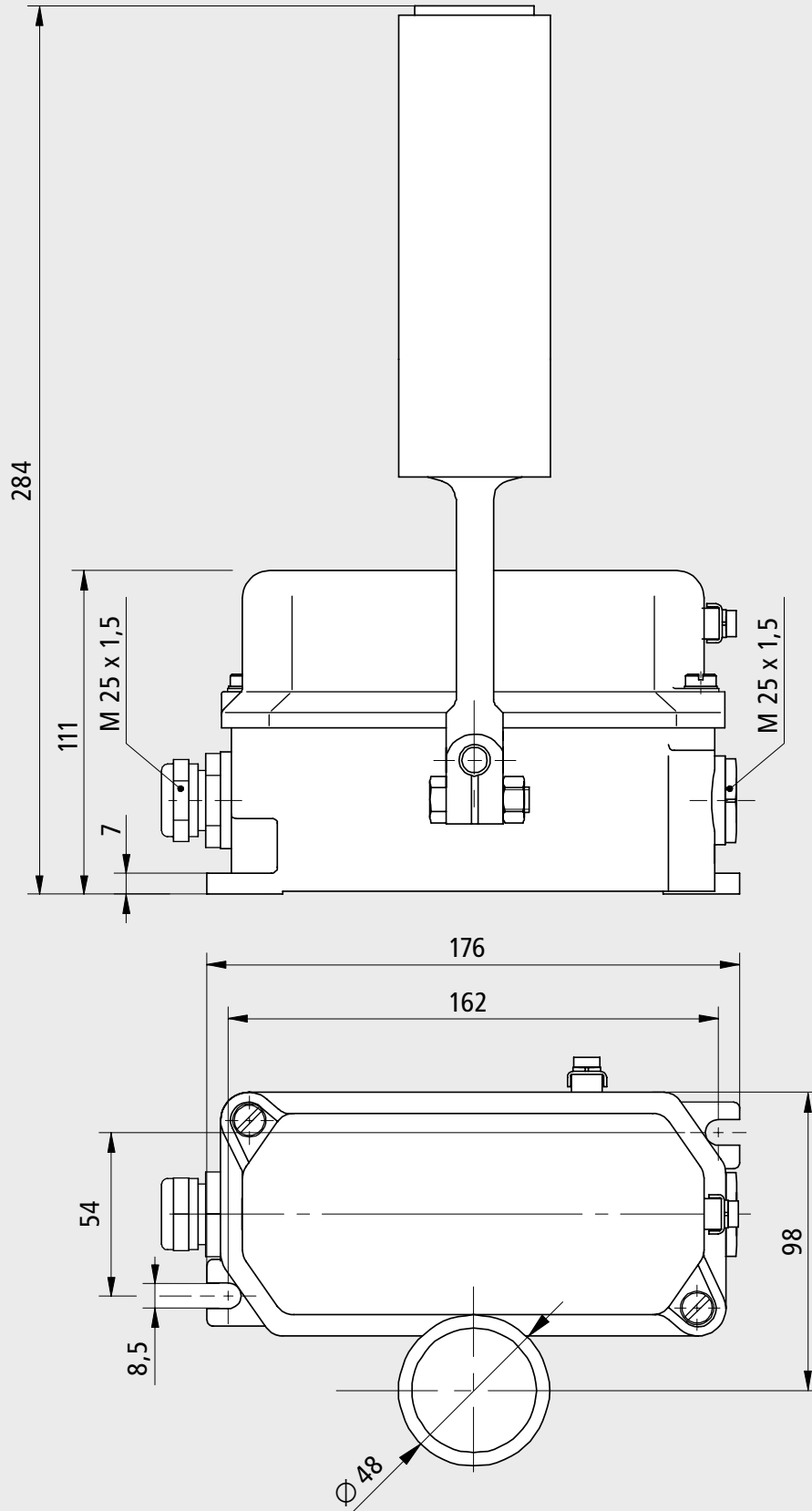

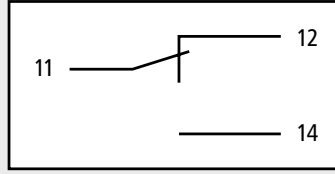
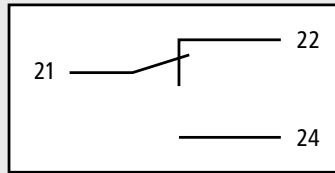

CONTACT ARRANGEMENTS



Position of Roller

Terminal markings corresponding to DIN EN 50013

CERTIFICATES

Translation
EC-Type Examination Certificate
- Directive 94/9/EC -
Equipment and protective systems intended for use
in potentially explosive atmospheres

BVS 03 ATEX E 409

(4) **Equipment:** Switch type *E*EX 0**
(5) **Manufacturer:** Vossloh Kiepe GmbH
(6) **Address:** D - 40599 Düsseldorf

(8) The certification body of EXAM BBG Prüf- und Zertifizier GmbH, notified body no. 0158 in accordance with Article 9 of the Directive 94/9/EC of the European Parliament and the Council of 23 March 1994, certifies that this equipment has been found to comply with the Essential Health and Safety Requirements relating to the design and construction of equipment and protective systems intended for use in potentially explosive atmospheres, given in Annex II to the Directive.
The examination and test results are recorded in the test and assessment report BVS PP 01.2265 EG.

(9) The Essential Health and Safety Requirements are assured by compliance with:
EN 50281-1-1:1998+A1 Dust explosion protection

(10) If the sign "X" is placed after the certificate number, it indicates that the equipment is subject to special conditions for safe use specified in the schedule to this certificate.

(11) This EC-Type Examination Certificate relates only to the design, examination and tests of the specified equipment in accordance to Directive 94/9/EC. Further requirements of the Directive apply to the manufacturing process and supply of this equipment. These are not covered by this certificate



(12) The marking of the equipment shall include the following:
Ex II 2 D IP 64 T 85 °C

EXAM BBG Prüf- und Zertifizier GmbH
Bochum, dated 01. December 2003

Signed: Dr. Jockers
Certification body

Signed: Dr. Eickhoff
Special services unit

Page 1 of 3 in BVS 03 ATEX E 409
This certificate may only be reproduced in its entirety and without change
Dienstleistungsadresse: 9 44809 Bochum Germany Phone +49 234 3096-102 Fax +49 234 3096-110

LCIE

(1) **NOTIFICATION DE L'ÉVALUATION RELATIVE A LA QUALITE DE PRODUCTION**

(2) Équipement ou système de protection ou composant destiné à être utilisé en atmosphères explosibles Directive 94/9/CE

(3) Numéro de notification LCIE 03 ATEX Q 8081

(4) Équipement ou système de protection ou composant tel qu'indiqué :
Interrupteurs de secours

(5) Demandeur :
VOSSLÖH KIEPE GMBH
Kiepe-Platz 1
D - 40599 Düsseldorf

(6) Fabricant :
VOSSLÖH KIEPE GMBH
Kiepe-Platz 1
D - 40599 Düsseldorf

(7) Le LCIE, organisme notifié sous la référence 0081 pour l'annexe IV conformément à l'article 9 de la directive 94/9/CE du Parlement européen et du Conseil du 23 mars 1994, notifie au demandeur que le fabricant a un système d'assurance qualité de production qui satisfait à l'annexe IV de la directive.

(8) Le système d'assurance qualité de production garantit la conformité de l'équipement ou du système de protection ou du composant pour le(s) type(s) décrit(s) en annexe.
L'équipement ou le système de protection ou le composant peut être placé sur le marché et mis en service, s'il est installé correctement et maintenu en état pour l'utilisation prévue.

(9) Cette notification, valable jusqu'au 16 décembre 2006, est fondée sur le rapport d'audit N° 60019151-011868.
Cette notification peut être retirée si le fabricant ne satisfait plus aux prescriptions de l'annexe IV.
Les résultats des réévaluations périodiques du système qualité font partie de cette notification.

(1) **PRODUCTION QUALITY ASSESSMENT NOTIFICATION**

(2) Equipment or Protective System or Component intended for use in Potentially explosive atmospheres Directive 94/9/EC

(3) Notification number LCIE 03 ATEX Q 8081

(4) Equipment or Protective system or Component as listed :
Safe Switches

(5) Applicant :
VOSSLÖH KIEPE GMBH
Kiepe-Platz 1
D - 40599 Düsseldorf

(6) Manufacturer :
VOSSLÖH KIEPE GMBH
Kiepe-Platz 1
D - 40599 Düsseldorf

(7) LCIE, notified body number 0081 for annex IV in accordance with article 9 of the directive 94/9/EC of the European Parliament and the Council of 23 March 1994, notifies to the applicant that the manufacturer has a production quality system which complies to annex IV of the Directive.

(8) The Production Quality Assurance guarantees conformity of the equipment or protective system or component with the type(s) described in the Schedule.
The equipment or protective system or component can be placed on the market and put into service if properly installed and maintained and used for its intended use.

(9) This notification, valid until December 16th, 2006, is based upon audit report N° 60019151-011868.
This notification can be withdrawn if the manufacturer no longer satisfies to the requirements of annex IV.
Results of periodical assessments of the quality system are a part of this notification.

Fontenay-aux-Roses, le 24 mars 2004

Le Directeur de l'organisme certificateur
Manager of the certification body

Marc Gillet
Timbre sécurisé seal

page 1/2

(9) Seul le texte en français peut engager la responsabilité du LCIE. Ce document ne peut être reproduit que dans son intégralité, sans aucune modification.
The LCIE's liability applies only on the French text. This document may only be reproduced in full and without any change. ATEX Q 409.1868/01206

LCIE
Laboratoire Central
des Industries Electriques
Une société de Bureau Veritas

35, av du Général Jackson
BP 9
92206 Fontenay-aux-Roses cedex
France

Tel : +33 1 40 95 00 00
Fax : +33 1 40 95 00 55
www.lcie.fr

Service européen à distance
et conseil de certification
au capital de 11 701 000 €
RCS Nanterre 0 409 303 174

Subject to change without notice.

Vossloh Kiepe GmbH

D-40599 Düsseldorf (Germany) · Kiepe-Platz 1
Phone +49(0)211 74 97-0 · Fax +49(0)211 74 97-420
info@kiepe-elektrik.com · www.kiepe-elektrik.com

51072-02/09